

Speed Dome

EPTZ1000

USER MANUAL



Table of Contents

1.	EPTZ1000OVERVIEW	1-3
1.1.	Introduction	1-3
1.2.	Specifications	1-5
1.3.	Feature	1-7
1.3.1.	Hardware Overview	1-7
1.3.2.	Base Board	1-8
1.3.3.	EPTZ1000Control Board	1-8
1.4.	EPTZ1000Connection.....	1-9
1.5.	EPTZ1000 Quick Operation Guide	1-10
2.	EPTZ1000 INSTALLATION	2-11
2.1.	Packing List	2-11
2.2.	Cable Needed.....	2-11
2.3.	Initial Setup	2-12
2.3.1.	Address Setting.....	2-13
2.3.2.	Communication Protocol Setting.....	2-16
2.3.3.	Transmission Speed Setting (Baud Rate Setting)	2-16
2.3.4.	Video Format Setting	2-17
2.4.	Rack and Speed Dome Installation	2-18
2.4.1.	Installation Requirements.....	2-18
2.4.2.	EPTZ1000 Dome Camera Wall Mount Installation	2-18
2.5.	Separately Sold Accessories.....	2-22
2.5.1.	Pole mount.....	2-22
2.5.2.	Pole adapter.....	2-22

2.5.3.	Corner mount	2-22
2.5.4.	Multi-Function Keyboard Controller	2-22
3.	EPTZ1000CAMERA SETUP MENU.....	3-23
3.1.	Structure of the Setup Menu.....	3-23
3.1.1.	Camera Setup Menu.....	3-24
4.	EPTZ1000FUNCTION SETUP AND OPERATION.....	4-30
4.1.	Manual Control Mode	4-30
4.2.	Auto Pan Mode	4-30
4.3.	Position Setting	4-31
4.4.	Tour Mode	4-32
4.5.	Alarm Link to a Position/Tour.....	4-33
4.6.	Other operations	4-34

1. EPTZ1000OVERVIEW

1.1. Introduction

EPTZ1000, an intelligent high-speed dome camera is ready to secure your property with its omni-directional and exact monitoring. An 18X optical and 12X digital zoom combining with a high-performance chip makes captured images clear and vivid. The other powerful camera functions this type of speed dome equips with:

- PAL / NTSC image format suppose.
- Auto and fast focus increases the searching speed and precision.
- Auto Iris adjusts the monitoring image to the best brightness.
- White Balance function makes the shades of color more natural in different light conditions.
- BLC (Backlight Compensation) function makes objects clear in a high illumination background.
- Color / B&W images auto switching to enhance the sensitivity in a low light condition or at night.

Furthermore, the micro control unit enables camera a nimble and exact movement from minimal $0.01^\circ/\text{sec}$ to maximal $360^\circ/\text{sec}$. It can go to every preset position in 1 second. It also has other advantages such as:

- 192 preset positions are available.
- 16 cruise tours can be set, and each tour contains up to 16 positions.
- Up to 256 speed domes can be supported on a RS485 bus when all speed domes are controlled by multi-function keyboard controller.
- Auto heater and fan to fit all kinds of temperature.
- Provide 4 alarm inputs and 1 alarm output.

All of the features make the intelligent high-speed dome camera works for a wide range and demanding application such as banks, airports, stations, casinos, streets of cities, intelligent buildings, and etc.

1.2. Specifications

Pickup Device	1/4" SONY Type EXview HAD CCD
Video Format	NTSC or PAL
Scanning System	NTSC: 525 TV lines, 60 fields/sec
	PAL: 625 TV lines, 50 fields/sec
Picture Elements	768 x 494 (NTSC) , 752 x 582 (PAL)
Horizontal Resolution	480 TVL
Sensitivity	0.7 Lux/F=1.4
S/N Ratio (AGC OFF)	Over 50dB
Electronic Shutter	1~1/10,000 (s)
Digital Slow Shutter	Yes
Shutter Selection	Yes
Lens Type	18x optical zoom , f=4.1 mm (wide) to 73.8mm (tele) , F1.4 to F3.0
Zoom Ratio	216x max (18x Optical and 12x Digital Zoom)
Day/Night	Yes
Black Light Comp.	ON/OFF
Auto Gain Control	Auto
White Balance	Auto/Indoor/Outdoor
Video Output	BNC 1.0Vp-p , 75ohm
Sync. Mode	Line Lock/Internal Sync
Power Source	24VAC
Power Consumption	18W; 70W with heater
Operating Temperature	-40°C~50°C ; -40°F~122°F
Focus Control	One push/Auto/Manual
Horizontal Rotation Speed	0.1°/s~360°/s (1-239 grade shift gears)
Horizontal Rotation Range	360° unlimited rotation
Tilt Rotation Range	90° pendulum motion
Auto Flip	Rotates 180° when camera tilts to the vertical position
Auto Zoom Speed Control	Control speed auto-adjusted according to zoom length changing
Auto Pan, 2 Points Scanning	Can set freely
Auto Pan Speed	1~239 grades available
Dwell Time (2 points)	1~239 second available

1.3. Feature

1.3.1. Hardware Overview

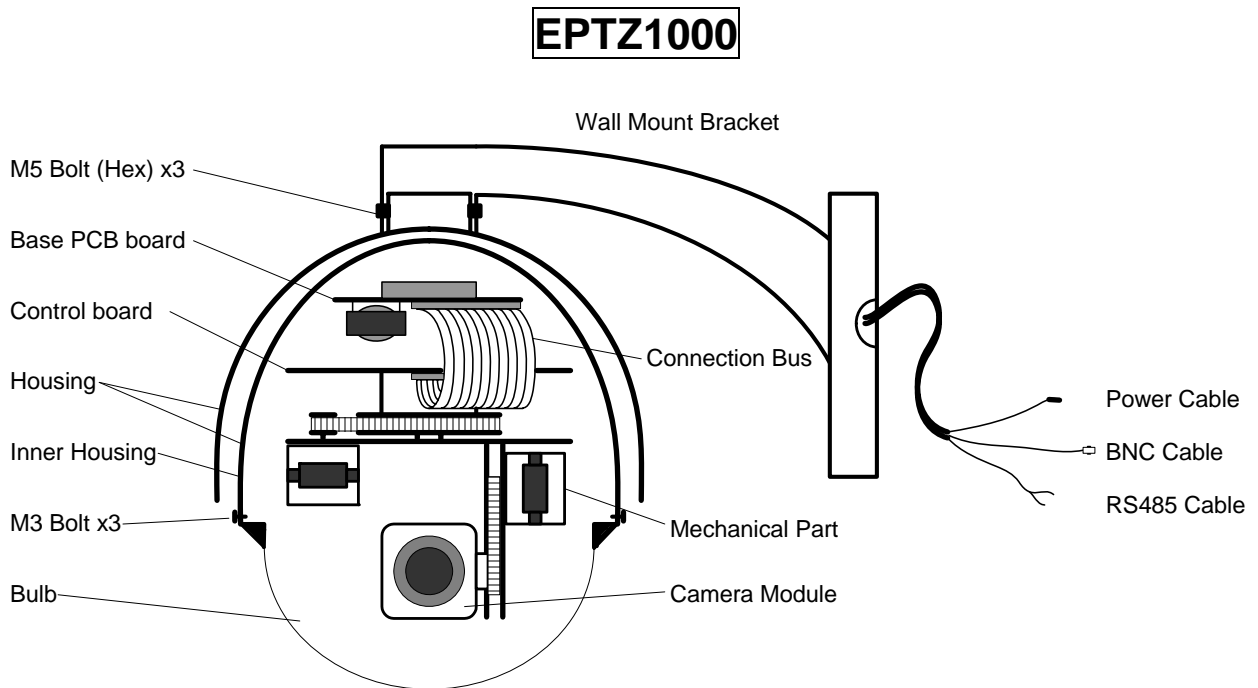

1.3.2. Base Board

The base board that is on the bottom of the housing connects to power cable, video cable, control cable, alarm cable, fan and heater (fan and heater are for EPTZ1000 only). In order to connect to cables, the board needs to be taken off, and put back after finishing connecting to all cables. The connectors of cable names are marked on the board in white text. The details of the alarm connector (JP5) are shown on the APPENDIX A.

For EPTZ1000, JP1, JP3 and JP6 that are two-pin connectors on the base board need to be taken off during installation. JP1 and JP3 are connectors for heater, and they can be switched. JP6 is a fan controller connector that turns on/off of the fan. The 3 cables are too short to be connected to a wrong connector when putting them back.

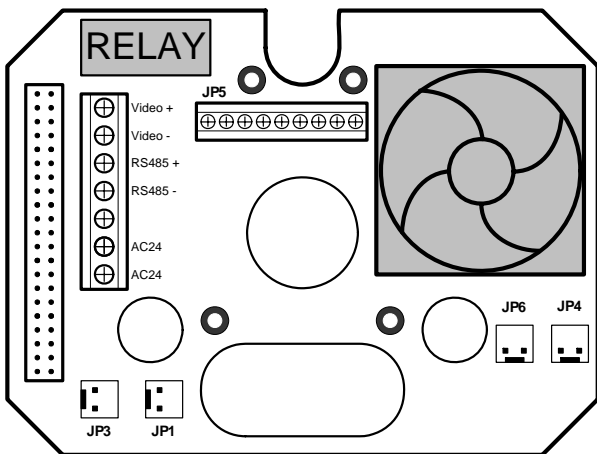

EPTZ1000 Baseboard

1.3.3. EPTZ1000Control Board

The PCB board with two dipswitches is the control board of speed dome. The two switches are used to set address, protocol, Baud Rate, video format and terminator resistance.

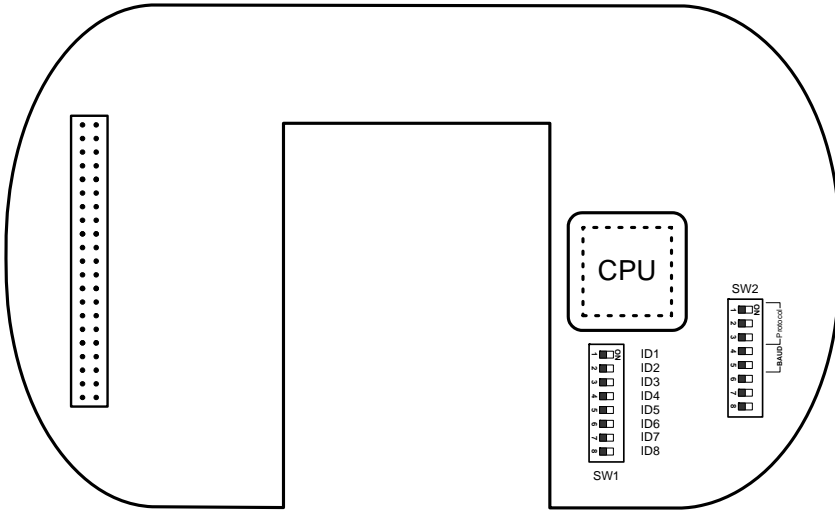

1.4. EPTZ1000Connection

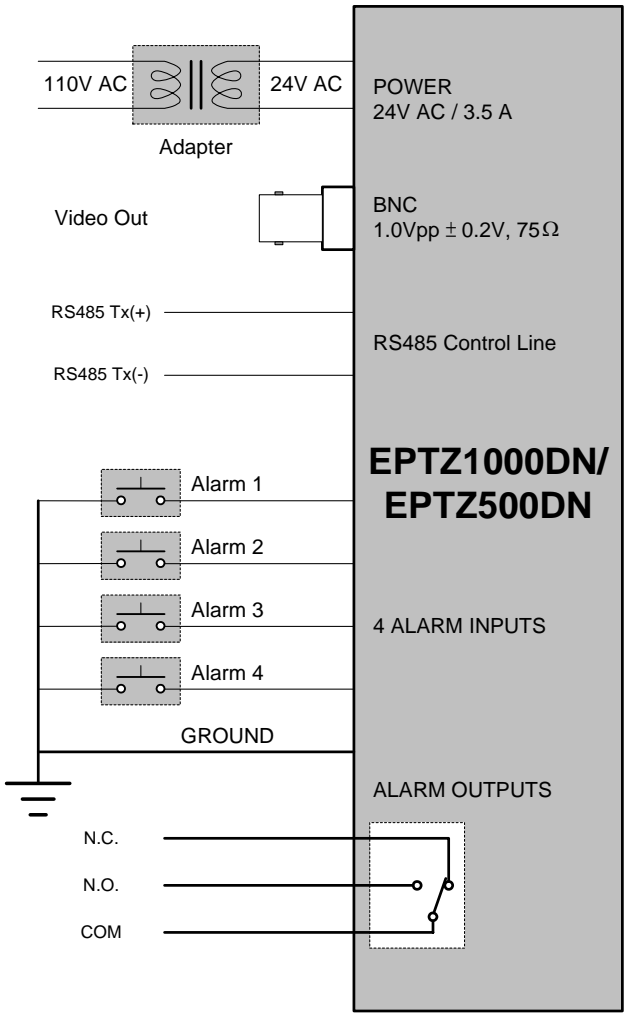

1.5. EPTZ1000 Quick Operation Guide

EPTZ1000 and EKB500 (Keyboard) can work together by using factory default setting. You just need to connect cables by following the steps:

1. Connect the RS485 cable to EPTZ1000 and a Keyboard (EKB500).
2. Connect a video cable from EPTZ1000 to a monitor.
3. Connect the power to the EPTZ1000 and a Keyboard (EKB500).

After the speed dome finishes the self-test mode, you can start to operate the speed dome via the keyboard.

To operate the EPTZ1000:

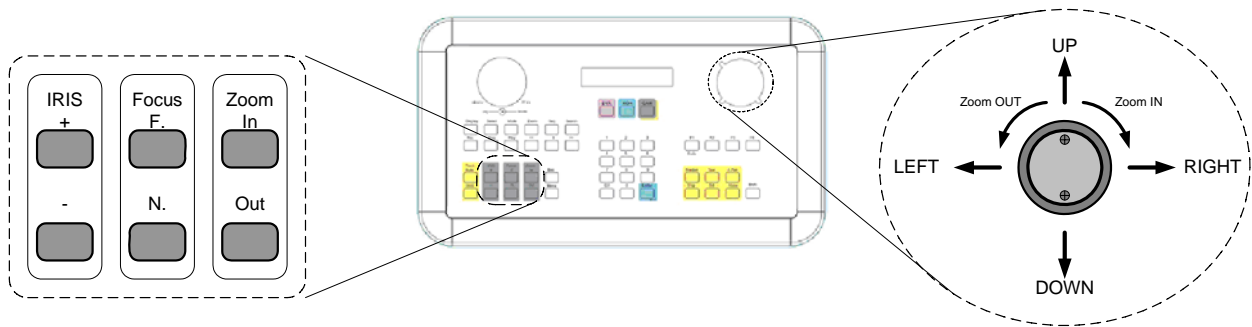

1. Shift the Joystick up/down or right/left to view from camera.
2. Turn the top of the Joystick to zoom in/out.
3. Press Zoom In/Out, Focus F. /N. and IRIS +/- function keys to operate the EPTZ1000.

2. EPTZ1000INSTALLATION

2.1. Packing List

There are 3 boxes that are housing, bulb and mechanical part with a camera module, one wall mount bracket, one power adapter and one accessory packet in the package. The detail accessories list below:

- Housing x1
- Bulb x1
- Mechanical part with a camera module x1
- Wall mount bracket x1
- Adapter x1
- Accessory packet
 - ✧ Glove x2
 - ✧ M5 Hex Allen wrench x1
 - ✧ Pin connector x1
 - ✧ M5 screw (Hex) x3 for wall mount bracket fixing
 - ✧ M3 screw x3 for bulb fixing
 - ✧ Anchor nut and wall mount screw x4

2.2. Cable Needed

- Power Cable

An adapter with 24V AC/3.5A output provides the power to the speed dome. An extension power line may be needed.

Note: The input AC voltage range of an adapter depends on different area.

Please make sure the voltage range before installing.

- Video Cable

A BNC cable is used for connecting a speed dome to a DVR or a monitor. An amplifier may be needed if the video cable is too long.

- Control Cable

Basically, EPTZ1000 uses a differential pair to connect to other devices by cascading. A cable that has low signal decline can be used as a control cable.

- Alarm Cable

An alarm cable is not included in the packing list. A suitable wire can be used as an alarm cable.

2.3. Initial Setup

Initial setup includes dome address, communication protocol, transmission speed, video format, and terminator resistance settings. All of the settings should be confirmed before the dome is installed. The control-related setting that is address, communication protocol and transmission speed have to be set consistently with the control device such as a keyboard or a DVR.

Notice: Please make sure the power is off before setting, and restart the speed dome to enable a new value after changing.

2.3.1. Address Setting







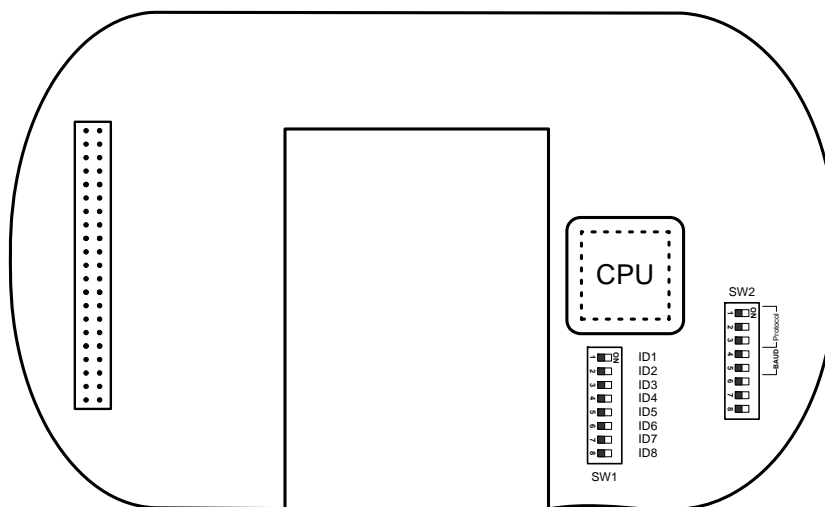













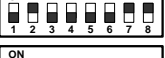
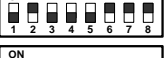













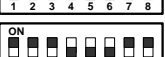
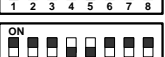



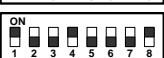
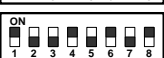



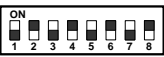
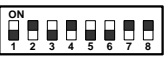
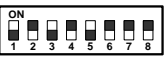

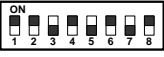





































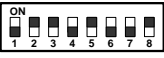





































The address code of the EPTZ1000 should be set to correspond properly with a control device to control multiple dome cameras. The address codes are made up by the dipswitch SW1 (8 bits) on the PCB board. The 8 bits dipswitch indicates the binary coded of the address, and there are 256 addresses can be selected ($0 \sim 255, 2^8 = 256$). It also means that there up to 256 dome cameras can cascade on the RS485 bus. The dipswitch setting and the indicated address are represented in the following chart.

Note: The factory default address is 1.

Notice: Please make sure the power is off before setting, and restart the speed dome to enable a new value after changing.



Switch	Address	Switch	Address	Switch	Address	Switch	Address
	0		32		64		96
	1		33		65		97
	2		34		66		98
	3		35		67		99
	4		36		68		100
	5		37		69		101
	6		38		70		102
	7		39		71		103
	8		40		72		104
	9		41		73		105
	10		42		74		106
	11		43		75		107
	12		44		76		108
	13		45		77		109
	14		46		78		110
	15		47		79		111
	16		48		80		112
	17		49		81		113
	18		50		82		114
	19		51		83		115
	20		52		84		116
	21		53		85		117
	22		54		86		118
	23		55		87		119
	24		56		88		120
	25		57		89		121
	26		58		90		122
	27		59		91		123
	28		60		92		124
	29		61		93		125
	30		62		94		126
	31		63		95		127

Switch	Address	Switch	Address	Switch	Address	Switch	Address
	128		160		192		224
	129		161		193		225
	130		162		194		226
	131		163		195		227
	132		164		196		228
	133		165		197		229
	134		166		198		230
	135		167		199		231
	136		168		200		232
	137		169		201		233
	138		170		202		234
	139		171		203		235
	140		172		204		236
	141		173		205		237
	142		174		206		238
	143		175		207		239
	144		176		208		240
	145		177		209		241
	146		178		210		242
	147		179		211		243
	148		180		212		244
	149		181		213		245
	150		182		214		246
	151		183		215		247
	152		184		216		248
	153		185		217		249
	154		186		218		250
	155		187		219		251
	156		188		220		252
	157		189		221		253
	158		190		222		254
	159		191		223		255

2.3.2. Communication Protocol Setting

The 1st, 2nd and 3rd bits of the SW2 are used to set communication protocol. The factory default protocol is EVF.

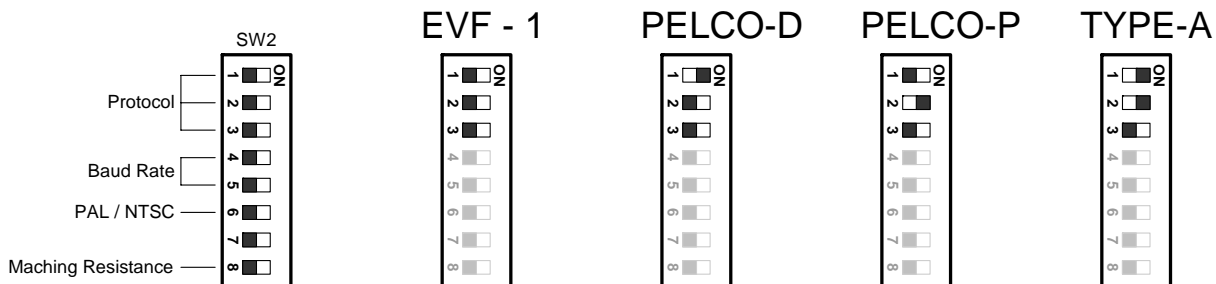

Notice: Please make sure the power is off before setting, and restart the speed dome to enable a new value after changing.

Set all of protocol switches to ON; the EPTZ1000 will enter a self-test mode.

2.3.3. Transmission Speed Setting (Baud Rate Setting)

The 4th and 5th bits of the SW2 on the PCB board are used to set the Baud Rate. The default baud rate setting is 9600.

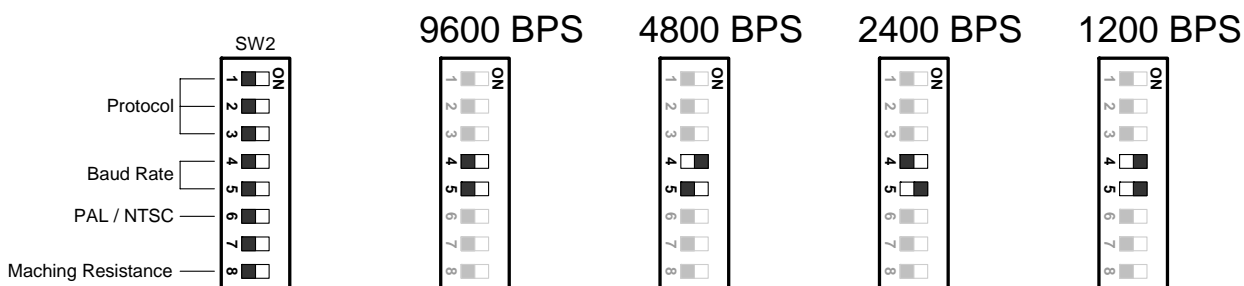

Notice: Please make sure the power is off before setting, and restart the speed dome to enable a new value after changing.

2.3.4. Video Format Setting

The 6th bits of the SW2 on the PCB board are used to set the video format. The default video format depends on the factory setting. Please do not change it.

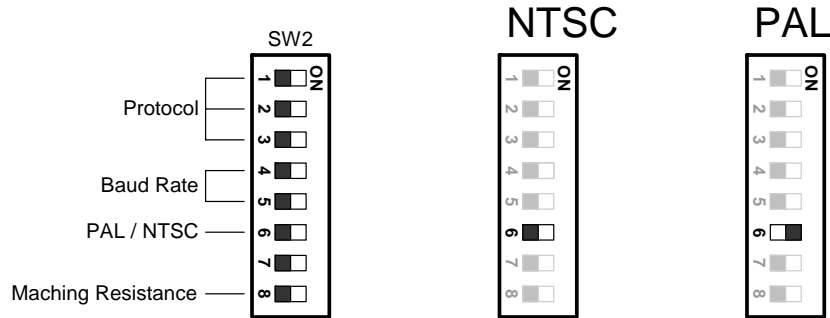

Notice: Please make sure the power is off before setting, and restart the speed dome to enable a new value after changing.

2.4. Rack and Speed Dome Installation

2.4.1. Installation Requirements

1. Installation should be handled by a qualified service agent and should comply with all local regulations. Service personnel should expect potential problems such as surface strength, surface material, falling objects, outer breaches, building vibration or other similar conditions.
2. Check for all necessary materials, and ensure if the selected installation location is suitable for the speed dome.

2.4.2. EPTZ1000 Dome Camera Wall Mount Installation

Notice: Installation location that is a wall, a pole or a ceiling needs to support above five times the total weight of the camera assembly (about 16 kg) to avoid shaken images, and dropping.

1. Set wall mount bracket on the wall. Mark the center of the holes on the wall against the bracket holes. Use a drill to make 4 holes that can be nailed 4 0.25" X 1.25" screws at the marks.

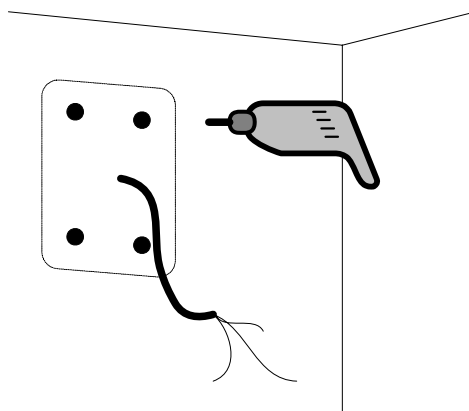

Notice: The length of the screws depends on the surface material. The mentioned screws are used in the normal concrete surface.

2. Thread the cable through the hole in the wall mount bracket, and screw in 4 M8 nuts for mounting the bracket.

3. Take off the housing from the packing, and take off the baseboard (4 bolts on it.) inside the housing. Thread the cable through the top of the housing. Fix the housing on the wall mount bracket, and screw in 3 M5 bolts (Hex) on the top of the bracket with the attached Hex Allen wrench to fix the housing.

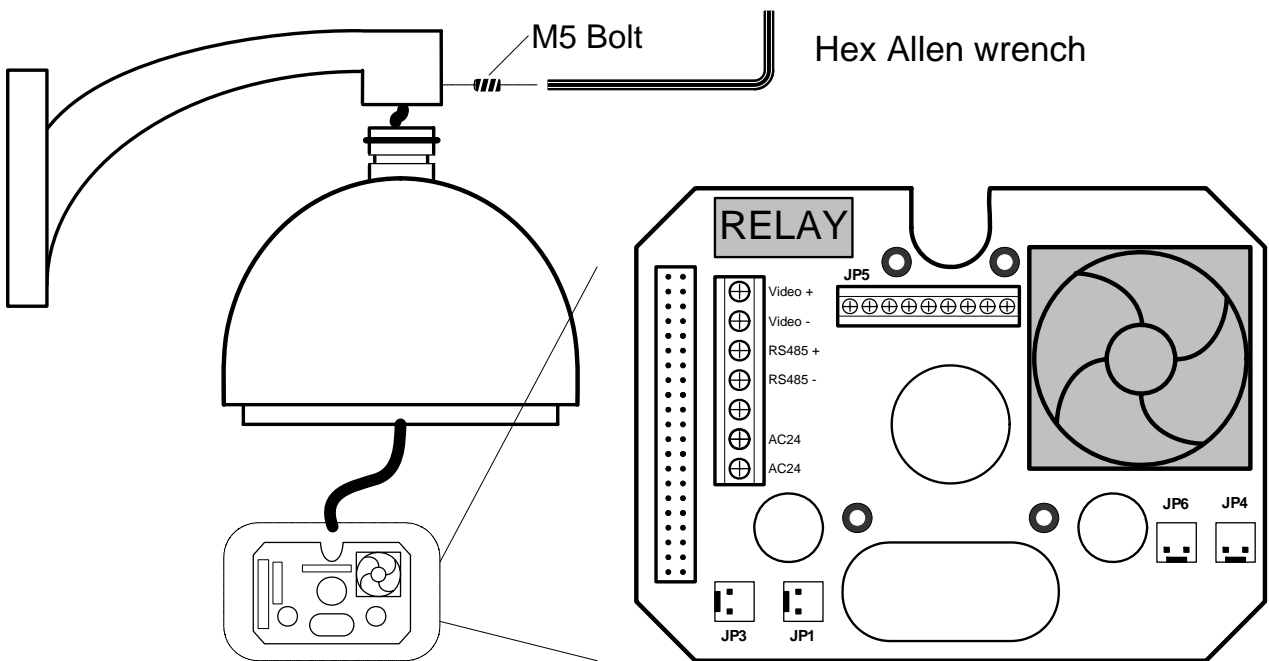

4. Connect the cable connectors to the nodes on the baseboard, and then fix the baseboard in the housing by screwing 4 bolts on it.

Notice: Please notice the polarity of control line. The EPTZ1000 will not work if the polarity of control line is mis-connected.

5. Align the two screw holes on the bottom of mechanical part to the two bolts on the base of the housing, and twist the mechanical part clockwise a little bit in order to engage it with the base. Screw the two bolts on the base, and then connect and fix the connection bus to the PCB board on the mechanical part.

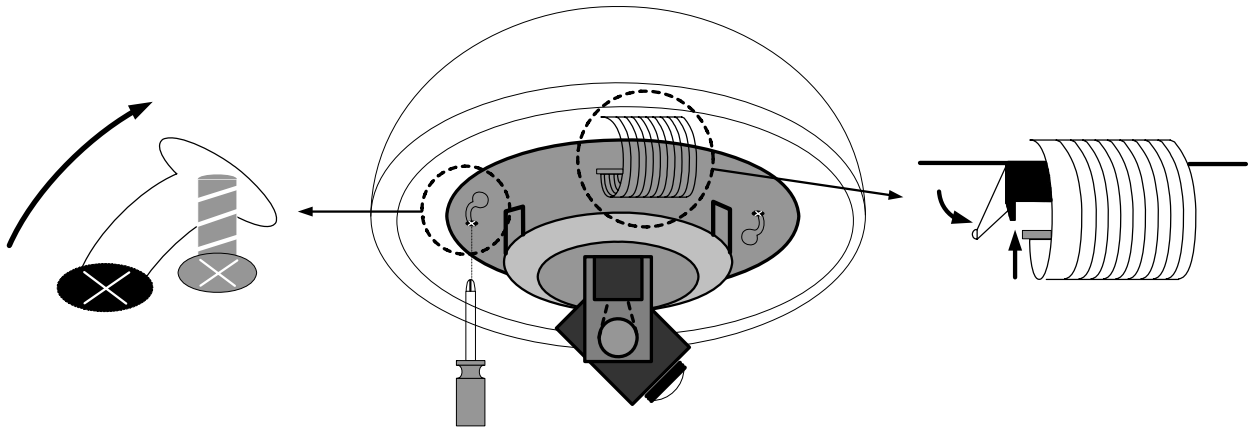

Notice: The camera module on the mechanical part is very sensitive. Please be careful when installing this part.

6. Remove the lens protection cover before installing the bulb. Align the 3 bolt holes into the 3 housing bolt holes, and screw thee M3 bolts with the attached small screw driver to fix the bulb.

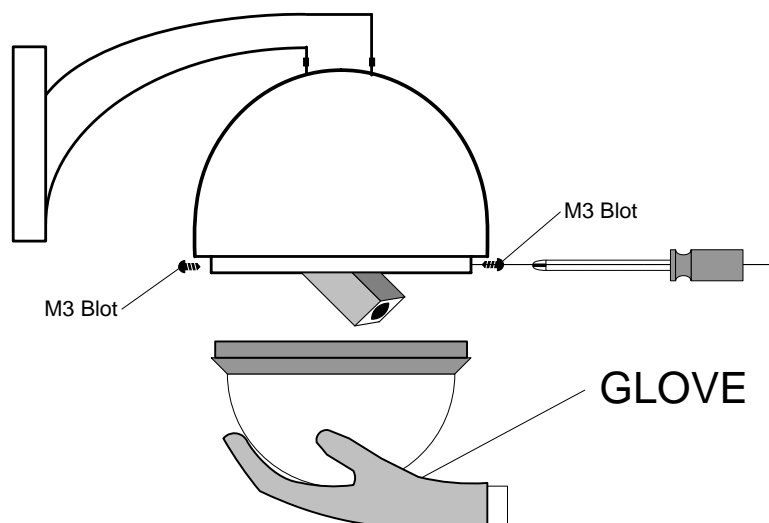

Notice: In order to protect the bulb from dirt and scrape, please put on the gloves before installing the bulb.

7. Turn on the power, and start to operate the EPTZ1000.

Note: When turning on the power, the EPTZ1000 will enter self-inspection mode, and carry out a self-testing program. After finishing self-inspection, you can start to operate the EPTZ1000.

2.5. Separately Sold Accessories

2.5.1. Pole mount

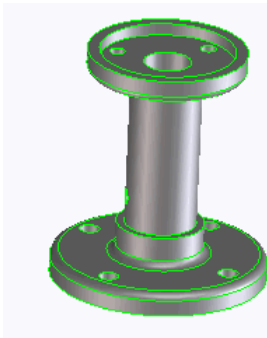

The pole mount is used for installing a speed dome on the ceiling indoors or outdoors.

The extension poles are available for the pole mount.

2.5.2. Pole adapter

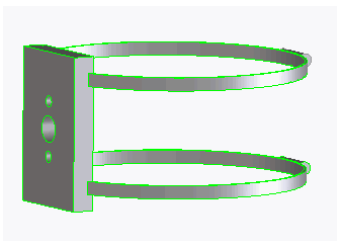

The pole adapter is used for installing a wall mount bracket to a pole indoors or outdoors.

2.5.3. Corner mount

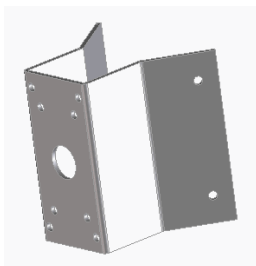

The corner mounts are used for installing a wall mount bracket to a 270° corner of walls indoors or outdoors.

2.5.4. Multi-Function Keyboard Controller



Multi-Function System Controller

Capable of controlling PTZ, DVR and Monitor

3D Joystick control of PTZ function

3. EPTZ1000CAMERA SETUP MENU

In this section, setup and operation guide of EPTZ1000 will be introduced. There are 25 items of the setting menu. However, there is only one line on the line display, so using some combination keys to operate is necessary.

3.1. Structure of the Setup Menu

Press **MENU** to enter camera setup menu.

Press **Shift** + Joystick up/down to change subentries, and right/left to change the setting.

Items	Option
→ CAM ID	-----
→ DZOOM	OFF / ON
→ FOCUS	AUTO / MAN / ONE PUSH
→ IRIS	AUTO / MAN
→ NEGATIVE	OFF / ON
→ S.SHUTTER	OFF / AUTO
→ COLOR	OFF / ON
→ DISPLAY	OFF / ON
→ BACKLIGHT	OFF / ON
→ WBC MODE	AUTO / INDOOR / OUTDOOR
→ TITLE DISPLAY	OFF / ON
→ AUTO FLIP	OFF / ON
→ ALM-IN1 SET	NIGHT N.O./ NIGHT N.C./ N.O. / N.C. / OFF
→ ALM-IN2 SET	N.O. / N.C. / OFF
→ ALM-IN3 SET	N.O. / N.C. / OFF
→ ALM-IN4 SET	N.O. / N.C. / OFF
→ ALM-IN PRIO	1234 / 2341 / 3421 / 4123
→ ALM-OUT	OFF/ LATCH / 3 /5 /10 /20 /30 /60 SEC
→ MOTION	OFF/ LIMIT ENT
→ TOUR	ENT
→ X CNT	0000000000
→ Y CNT	0000000000
→ PO CNT	0000000000
→ LOAD DEFAULT	-----
→ EXIT MENU	-----

3.1.1. Camera Setup Menu

Press **MENU** to enter camera setup menu.

Press **Shift** + Joystick up/down to change subentries, and right/left to change the setting.

1. CAM ID : The name assigned to the camera.

2. DZOOM : Digital zoom enable or disable.

ON: Enable a digital zoom.

OFF: Disable a digital zoom.

3. FOCUS : Focus type, auto focus and manual focus are available.

AUTO: Auto focus is enabled.

MAN: Manual focus is enabled.

ONE PUSH: Enable the one push trigger focus mode. The focus lens holds the same position until the next trigger command is received. This function prevents the wrong focus in dark. This option is the default value.

4. IRIS : IRIS type, auto iris and manual IRIS are available.

AUTO: Auto IRIS is enabled.

MAN: Manual IRIS is enabled.

5. NEGATIVE : Negative image.

ON: Enable a negative image.

OFF: Disable a negative image.

6. S.SHUTTER : (this function is only available for EPTZ1000)

OFF: Disable auto slow shutter.

AUTO: Auto Slow electrical shutter. In order to enhance the view in the low lux environment, slow shutter allows more light go through the shutter.

7. COLOR : Color display.

ON: Enable a color display.

OFF: Disable a color display, and show a B&W display.

8. DISPLAY : Display system information and status.

ON: To display the system information and status on the screen.

OFF: Not to display the system information and status on the screen.

9. BACKLIGHT : Backlight compensation.

ON: Enable backlight compensation.

OFF: Disable backlight compensation.

10. WBC MODE : White balance mode.

AUTO: Auto white balance mode.

INDOOR: Indoor white balance mode.

OUTDOOR: Outdoor white balance mode.

11. TITLE DISPLAY : Display the title.

ON: Enable title display.

OFF: Disable title display.

12. AUTO FLIP : Flip the camera when it tilts to the 90° end.

ON: Enable auto flip.

OFF: Disable auto flip.

13. ALM-IN1 : The status of input alarm 1.

NIGHT N.O.: Dome turns to “Night mode” if external contact open. Dome turns to “Day mode” if external contact closed.

NIGHT N.C.: Dome turns to “Night mode” if external contact closed. Dome turns to “Day mode” if external contact open.

N.O.: Enable a normal open alarm input.

N.C.: Enable a normal close alarm input.

OFF: Disable alarm input.

14. ALM-IN2 : The status of input alarm 2.

N.O.: Enable a normal open alarm input.

N.C.: Enable a normal close alarm input.

OFF: Disable alarm input.

15. ALM-IN3 : The status of input alarm 3.

N.O.: Enable a normal open alarm input.

N.C.: Enable a normal close alarm input.

OFF: Disable alarm input.

16. ALM-IN4 : The status of input alarm 4.

N.O.: Enable a normal open alarm input.

N.C.: Enable a normal close alarm input.

OFF: Disable alarm input.

17. ALM-IN PRIO : The priority of alarms.

1234: The alarm priority is 1>2>3>4.

2341: The alarm priority is 2>3>4>1.

3412: The alarm priority is 3>4>1>2.

4123: The alarm priority is 4>1>2>3.

18. ALM-OUT : Duration time of the alarm output.

OFF: Disable alarm output.

3 / 5 / 10 / 20 / 30 / 60 SEC: The duration of the alarm output sustains in seconds.

LATCH: The alarm output will not stop until there is any operation on keyboard.

19. MOTION: This is used to set a limitation for Auto Pan function. When Motion is ON, you can use Auto Pan function simply by pressing “Shift”+ “A.Pan” of the keyboard (according to A. Pan position you have set).

OFF: Motion limitation function is disabled.

LIMIT: Press “Enter” first.

The message **NOW LIMIT OFF** shows up, press “Enter” again.

The message **CHANGE ON** shows up, press “Enter” to change.

To change the value back to OFF, simply follow the same steps again.

If you need to reset, press “IRIS -” of the keyboard to exit.

20. TOUR : Tour setting or tour run option. Press “Enter” first to enter tour mode.

Shift joystick to right and left (< >), shift SET or RUN option. (Shift the joystick up for returning to previous setting). Press “Enter” to confirm.

For Tour setting: Shift joystick to right and left (< >) for changing Set Numeral

(T01A~T16A), then press “Enter” to confirm.

Shift joystick to right and left for selecting PRE Numeral (position) from 01~99, then press “Enter” to confirm.

Shift joystick up and down to adjust DWL (dwell) time from 0~99 sec, then press “Enter” to confirm.

Shift joystick to right and left for adjusting speed (5~235, with an interval of 5), then press “Enter” to confirm.

For Tour Run:

Shift joystick to right and left for selecting RUN NUM (T01A~T16A) of the tour that you previously set. Press “Enter” to start running the tour.

Alternatively, you could run the tour without entering MENU. Press “Position + 97” to run the tour that you have previously set, please be informed that this function is only valid for T01A.

If you need to reset, press “IRIS -” of the keyboard to exit.

21. X CNT : X-axis counter. This counter counts the x axis movement, and 1 is counted when the speed dome pans 360°.

22. Y CNT : Y-axis counter. This counter counts the y axis movement, and 1 is counted when the speed dome tilts 180°.

23. PO CNT : Position counter. This counter counts the go-position times, 1 is counted when speed dome goes to a position once.

24. LOAD DEFAULT : Load default setting.

Select this item, and then press "Enter" to load default setting.

Press "Clr" + "Menu" whenever you want to quit menu setting.

25. EXIT : To exit.

Select this item, and then press "Enter" to quit setting.

Press "Clr" + "Menu" whenever you want to quit menu setting.

4. EPTZ1000FUNCTION SETUP AND OPERATION

4.1. Manual Control Mode

- **Manual control:** Shift Joystick Up/Down/Left/Right, and turn it Clockwise/Counterclockwise to control speed dome.

Use the control keys which are Zoom, Focus and IRIS function keys on the keyboard to zoom In/Out, focus N (near)/F (Far), or IRIS +/-.

Note: Zoom In/Out control keys will be disabled when entering to OSD menu mode.

- **HOME Mode:** The camera view will go back to the home position when there is no keyboard operation in a specific time. The home position and the specific time can be set by press **Set** + **Home**.

If you set the time to 0 minute, then the camera will go back to home if there is no keyboard operation in 5 seconds. This is the minimum no action time for HOME mode.

Note: If "HOME" function is enabled, dome will go to home immediately after powering on.

4.2. Auto Pan Mode

- **Two point auto pan:** Press **A.Pan** to enter the auto pan mode, and then the system will ask you to enter the auto pan speed (1~239). Press **Enter** to start auto pan.

In order to set the two points, press **Set** + **A.Pan**, and then enter the dwell time (1~239 seconds) of each point. EPTZ3000 begins to pan from point A to point B clockwise.

- **360° auto pan:** Press **Shift** + **A.Pan** to enter the 360° auto pan. System will ask you

to enter 360° auto pan speed (1~239). The camera will turn 360° automatically, but not tilt.

4.3. Position Setting

- **Focus on a preset position:** Press the number key, and then press **Position** to focus on the number of preset position; or you can press **Position**, then enter the preset position number, and then press **Enter** to focus on the number of preset position.
- **Preset a position:** Shift the Joystick to the position you would like to preset, and then press **Shift** + **Position**. The system will ask you to enter the preset position number (1~192), and then press **Enter** to save the position. There are up to 192 positions can be preset.

Three specific preset positions can be set as follows:

92 => Set Left Limit Stop (A position)

93 => Set Right Limit Stop (B position)

95 => Enter Menu mode (Use keyboard control keys to control OSD items; **Focus F.** to go downward, **Focus N.** to go upward. **IRIS +** go to previous setting and **IRIS -** to exit).

You can directly go to the following specific preset positions:

33 => Rotation of 180 degree

34 => Go to Home position (if Home Position is set by EVF Keyboard)

96 => Stop Scan

97 => Start running tour

98 => Frame scan (60 degree / step)

Default speed is 32. It can be changed by EVF Keyboard (**Shift** + **A.Pan** setting speed).

Dwell time: default is 2 sec; It can be changed by EVF Keyboard **Set** + **A.Pan** setting dwell time of A pos or B pos.

99 => Auto scan (360 degree)

Default speed is 32. It can be changed by EVF Keyboard (**Shift** + **A.Pan** setting speed).

For EPTZ1000, We can even set camera's ICR Day/Night function with RS-485 command via keyboard. How to do this? Press **Position** + **88** to link to Day mode or **Position** + **89** to link to Night mode, "ICR AUTO" message will be shown on the right-bottom part of the screen. If OSD Day/Night ICR mode is "AUTO", it cannot be controlled by preset position setting.

- **Set the parameter of a preset position:** Press **Set** + **Position** to set the parameter of a preset position. You can set the going-to speed (1~239), dwell time (1~239 seconds), and the title of the position. Shift the joystick Right/Left to change bits, and shift the Joystick Up/Down to change the alphanumeric characteristic. The available alphanumeric characteristics are 0~9, A~Z, &, ?, !, :, ', ., ,, /, -, and a space.
- **Delete a preset position:** Press **Clr** + **Position** to delete a preset position. The system will ask you to enter the position number that you would like to delete, and then press **Enter**.

4.4. Tour Mode

In the tour mode, you can set a tour for viewing. There are 16 tours can be set, and 16 preset positions in a tour.

- **One-way tour Mode:** Press **Tour** to enter the tour mode. The system will ask you to enter the tour number you would like to run, and starts the tour after pressing **Enter**. To preset a tour before running it is necessary.

Preset a one-way tour: Press **Set** + **Tour** to preset a one-way tour. The system will ask you to enter preset position numbers (The positions need to be preset). After finish entering all positions, press **Stop** to quit, and then press **Enter** to save the tour.

- **To-and-fro tour mode:** Press **Shift** + **Tour** to run a to-and-fro tour. The system will ask you to enter the tour number you would like to run, and starts the tour after pressing **Enter**. To preset a tour before running it is necessary.

Note 1: The difference between the One-way tour mode and To-and-fro tour mode is their return modes. For example: There is a tour with 3 preset positions 1, 2 and 3. The camera runs 1→2→3→1→2→3 in the One-way tour mode, and 1→2→3→2→1 in the To-and-fro tour mode.

Note 2: You could set a pattern tour. Press **Set** + **Tour**, and input 0, press **Enter**. Sway the joystick to record the entire tour. Press **Stop** to stop recording tour. To view this pattern tour, simply press **Tour**, and input tour number 0.

4.5. Alarm Link to a Position/Tour

The EPTZ1000 has 4 alarm inputs that can be set to link to a position or a tour when an alarm is triggered.

- **Set an alarm link:**

Press **F1** to set an alarm link. Enter the alarm number, and then press **Enter**.

Switch the Joystick up/down to select a position or a tour, enter a position or tour number, and then press **Enter** to confirm the alarm link setting.

If you set the position number to 99, the dome will do a 360 degree auto scan or AB two point pan if limit is ON. If you set the position number to 98, the dome will do a frame scan.

➤ **Delete an alarm link:**

Press **Cir** + **F1** to delete a link of alarm to position/tour.

Note 1: After alarm output signal is terminated, the speed dome will resume action or return to its original position.

Note 2: After powering on the speed dome, it will detect alarm status automatically.

4.6. Other operations

The EPTZ1000 can work with a DVR that has PTZ control functions, and a matching protocol. The available control functions depend on different DVRs.

The EPTZ1000 can work with a keyboard that has PTZ control functions, and a matching protocol. The available control functions depend on different keyboards.

APPENDIX A: The Alarm I/O Connection

There are 4 alarm inputs and 1 alarm output available. The alarm I/O connector that is marked as **JP5** is a nine-pin connector. It is located on the PCB board of the housing.

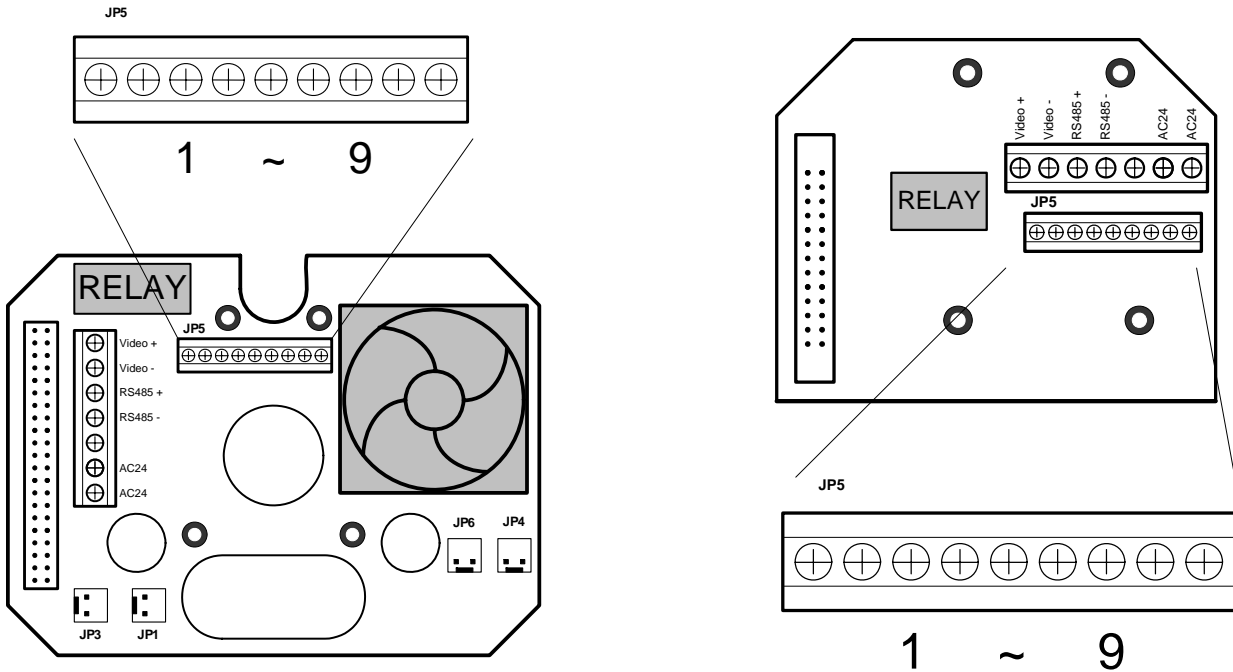

EPTZ1000 base board

Pin #	Function
1	Alarm Input 4
2	Ground
3	Alarm Input 3
4	Alarm Input 2
5	Ground
6	Alarm Input 1
7	Normal Open (N.O.)
8	Common (COM)
9	Normal Close (N.C.)

EverFocus Electronics Corp.

Head Office:

12F, No.79 Sec. 1 Shin-Tai Wu Road,
Hsi-Chih, Taipei, Taiwan
TEL: +886-2-26982334
FAX: +886-2-26982380
www.everfocus.com.tw

USA L.A. Office:

1801 Highland Ave. Unit A
Duarte, CA 91010, U.S.A.
TEL: +1-626-844-8888
FAX: +1-626-844-8838
www.everfocus.com

USA N.Y. Office:

415 Oser Avenue Unit S
Hauppauge, NY 11788
Tel: 631-436-5070
Fax: 631-436-5027
www.everfocus.com

Europe Office:

Albert-Einstein-Strasse 1
D-46446 Emmerich, Germany
TEL: 49-2822-9394-0
www.everfocus.de

China Beijing Office:

Room B-05D-1, KESHI PLAZA , Shangdi Information
Industry Base,
Haidian District, Beijing China
100085
TEL: +86-10-62973336/37/38/39
FAX: +86-10-62971423
www.everfocus.com.cn

Japan Office:

1809 WBG MARIBU East 18F,
2-6 Nakase.Mihama-ku.
Chiba city 261-7118, Japan
TEL : +81-43-212-8188
FAX : +81-43-297-0081
www.everfocus.com



Your EverFocus product is designed and manufactured with high quality materials and components which can be recycled and reused. This symbol means that electrical and electronic equipment, at their end-of-life, should be disposed of separately from your household waste. Please, dispose of this equipment at your local community waste collection/recycling centre. In the European Union there are separate collection systems for used electrical and electronic product. Please, help us to conserve the environment we live in!

Ihr EverFocus Produkt wurde entwickelt und hergestellt mit qualitativ hochwertigen Materialien und Komponenten, die recycelt und wieder verwendet werden können. Dieses Symbol bedeutet, dass elektrische und elektronische Geräte am Ende ihrer Nutzungsdauer vom Hausmüll getrennt entsorgt werden sollen. Bitte entsorgen Sie dieses Gerät bei Ihrer örtlichen kommunalen Sammelstelle oder im Recycling Centre. Helfen Sie uns bitte, die Umwelt zu erhalten, in der wir leben!



P/N: MW01G0040B Ver. C